

Flow injection spectrophotometric determination of amoxicillin in pharmaceutical samples by coupling with diazotized *p*-nitroaniline

M. Q .Al-Abachi

*** H. Hadi**

**Dept. of Chemistry,
College of Science, Uni. of Baghdad**

Abstract

A spectrophotometric method using flow injection analysis (FIA) is described for the determination of amoxicillin (AMX). Its detection limit, linearity and reproducibility were examined. The automated method is based on a coupling reaction between AMX and diazotized *p*-nitroaniline (DPNA) in alkaline medium to form an intense reddish-orange, water-soluble dye that is stable and has a maximum absorption at 478 nm. The calibration graph was linear over the concentration range of 0.5-100 $\mu\text{g}\cdot\text{ml}^{-1}$ with a detection limit of 0.104 $\mu\text{g}\cdot\text{ml}^{-1}$ and sample throughput of 60 h^{-1} . The proposed method was successfully applied to the determination of AMX in injections and capsules.

Introduction:

Amoxicillin (AMX), 6-(*p*-hydroxy- α -amino phenyl acetoamido) penicillanic acid, is the *p*-hydroxy analogue of ampicillin but possesses some significant advantage over ampicillin, include more complete gastrointestinal absorption, and little or no effect on absorption of food (1). The British pharmacopoeia recommended a liquid chromatography (LC) and spectrophotometric (using imidazol-mercury reagent) methods for the determination of AMX in raw material and dosage forms respectively (2).

The literature reported several analytical procedures for the determination of AMX in pure form or in pharmaceutical formulations as well as in biological fluids. It included spectrophotometric (3; 4), polarographic (5; 6), fluorimetric (7; 8), flow injection analysis (9) and HPLC methods (10; 11). Recently a flow injection spectrophotometric method is developed for the determination of AMX in capsules and injections based on using *N,N*-dimethyl-*p*-phenylenediamine and potassium hexacyanoferrate (III) in alkaline medium to form a blue soluble product that can be measured at λ_{max} of 660 nm (12). Various FIA-spectrophotometry methods based on diazotization and

* Part of M.Sc. thesis for the second author

coupling reactions have been developed for the determination of drugs such as metronidazole (13), sulphonamide (14), acetaminophene and dopamine (15).

The purpose of the present investigation is to develop a simple and sensitive method for the determination of AMX in pharmaceutical preparations using diazotization coupling reaction and FIA-spectrophotometer. The proposed method is based on a coupling reaction between AMX and DPNA in alkaline medium (16) to form an intense reddish-orange color product which shows an absorption maximum at 478 nm.

Reaction mechanism of the method:

Amoxicillin forms a reddish-orange colored product (λ max at 478 nm) with DPNA in alkaline medium. Due to the phenolic nature of AMX, it can readily be coupled with a chromogenic reagent (DPNA) according to scheme 1. The reddish-orange dye product was only formed in alkaline medium (sodium hydroxide) since AMX is converted into its salt (phenoxide ion). The later is more stable than phenol (resonance) leading to a more stable intermediate with DPNA (17).

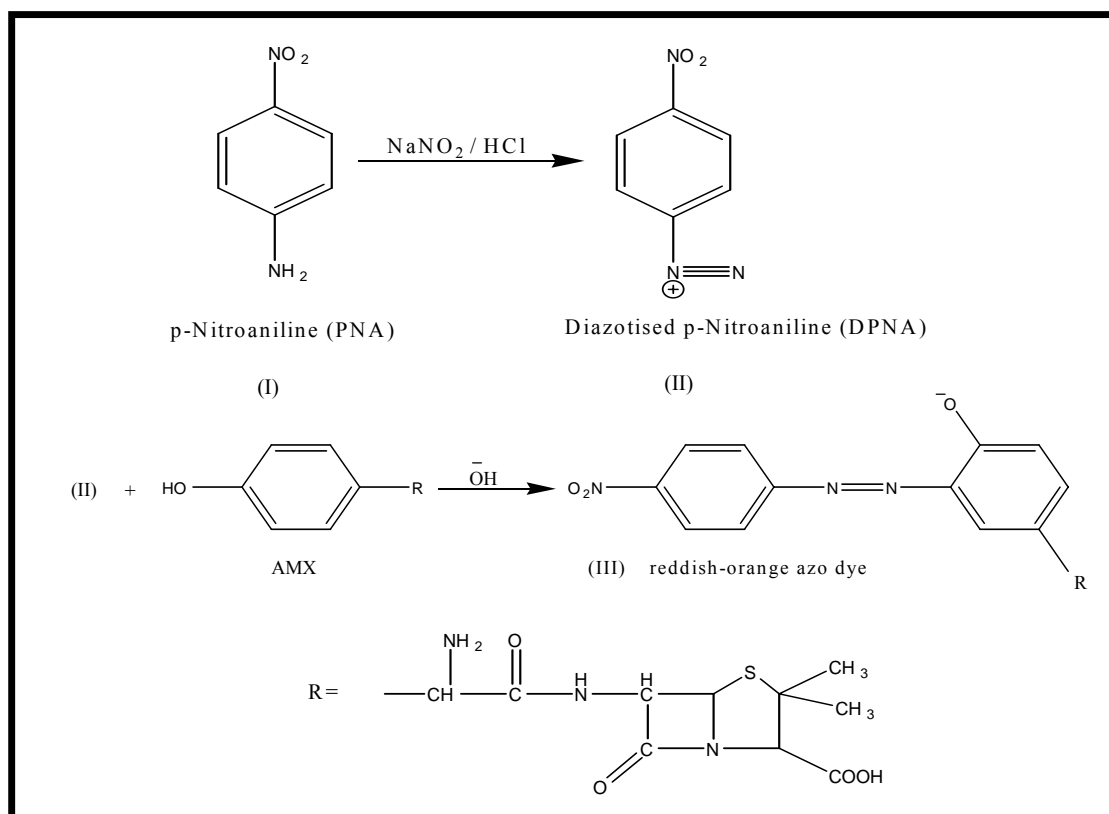

Scheme 1: Proposed mechanism of the reaction between AMX and DPNA

Experimental

Apparatus:

Shimadzu UV-Vis 260 digital double beam recording spectrophotometer with a flow cell of 50 μl internal volume and 1cm bath length were used for all absorbance measurements. A two-channel manifold (Fig. 1) was employed for the FIA spectrophotometric determination of AMX in pure and dosage forms. A peristaltic pump (Ismatec, Labortechnik-Analytik, CH-8152, Glatbrugg-Zurich-Switzerland) was used to transport the carries solutions. (Rheodyne, Altex 210, supelco-USA) injection valve was employed to provide appropriate injection volumes of standard solutions and sample. Flexible vinyl tubing of 0.5 mm internal diameter was used for the peristaltic pump. Reaction Coil (RC) was of Teflon with internal diameter of 0.5 mm.

Channel (A) was used to transport DPNA solution and channel (B) to transport Sodium hydroxide solution. The sample was injected into the stream of DPNA solution through the injection valve and was then mixed with the stream of sodium hydroxide solution. Solutions were propelled by peristaltic pump with individual flow rate of 0.75 ml.min⁻¹ and the absorbance was measured at 478 nm .

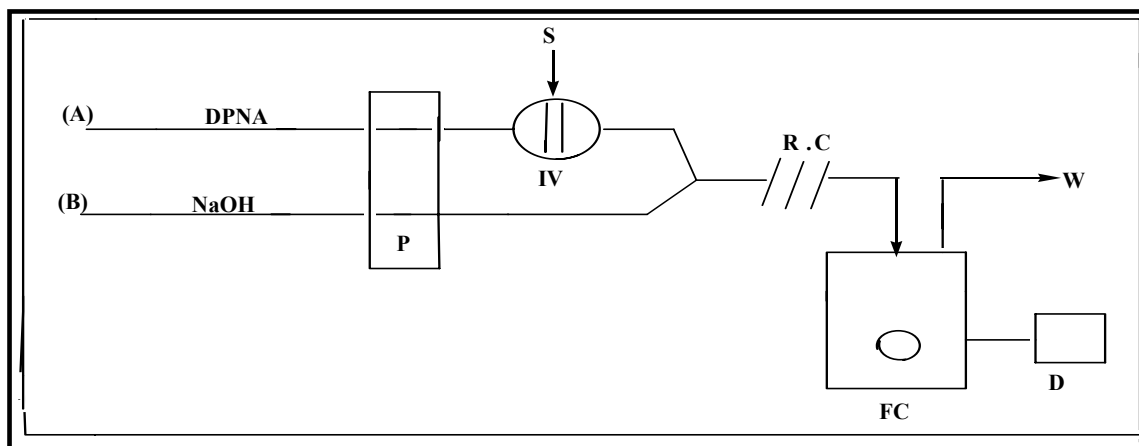

Fig. 1: Manifold employed for FIA-Spectrophotometric determination of AMX with DPNA solution in alkaline medium where: A, 5 mM of DPNA solution; B, 20 mM of sodium hydroxide solution; IV, Injection valve; R.C, Reaction Coil; S, Sample; P, Peristaltic pump; F. C, Flow cell; D, Detector; W, Waste.

Reagents and materials:

All chemicals used were of analytical reagent grade and distilled water was used throughout. Pure amoxicillin drug sample was kindly provided from state company for Drug Industries and Medical Appliance, SDI, Samara. Iraq.

Dosage forms were obtained from commercial sources. *p*-Nitroaniline, PNA (Merck).

Diazotized *p*-nitroaniline (DPNA), 5 mM was prepared daily by dissolving 0.0690 gm of PNA in about 70 ml of distilled water (heating may be required), add 3 ml of 800 mM hydrochloric acid in a 100 ml volumetric flask. Cool the mixture to 0-5 °C for 5 min using an ice-bath. Add 0.0345 gm amount of sodium nitrite (Merck) and stir the mixture. After 5 min the volume is made up to the mark with distilled water. More dilute solutions were prepared by suitable dilute with distilled water.

Sodium hydroxide, (BDH), 100 mM solution and hydrochloric acid, (Fluka) 800 mM solution were prepared by dilution of concentrated solutions.

Amoxicillin stock solution, 1000 µg ml⁻¹. A 0.1000 gm amount of AMX was dissolved in 10 ml ethanol in a 100 ml calibrated flask and the solution was made up to the volume with distilled water. Serial dilutions with distilled water were made to cover the working range.

Recommended procedure:

Samples containing different concentrations 0.5-100.0 µg ml⁻¹ of AMX were prepared by simple dilution of the stock solution with distilled water. The FIA- spectrophotometric measurements were carried out using the manifold shown in Fig.1, by injection of 150 µl AMX into a stream of 5 mM of DPNA reagent which was then combine with 20 mM sodium hydroxide stream. The flow rate in each channel was 0.75 ml min⁻¹ and the absorbance of the resulting reddish-orange dye was measured at 478 nm. A 100 µg ml⁻¹ of AMX was used for the optimization of conditions in FIA system.

Analysis of Pharmaceutical preparations:

An accurately weighed amount of 10 powdered capsules or mixed content of 10 vials equivalent to 100 mg of the pure drug, was transferred into a 100 ml calibrated flask and was dissolved in 10 ml ethanol and completed to the mark with distilled water. The flask with its contents was shaken well and filtered. A sample of 2500 µg of AMX in a final volume of 25 ml was taken and the measurement was carried out as described earlier under general procedure.

Results and discussion of the method

Amoxicillin forms reddish-orange colored product ($\lambda_{\text{max}}=478 \text{ nm}$) with DPNA in the presence of sodium hydroxide. The absorption spectrum of the colored product is shown in (Fig. 2). The absorbance is directly related to the concentration of AMX and can be used for its spectrophotometric determination. The development of the color product depends on the reaction conditions and was optimized as follows.

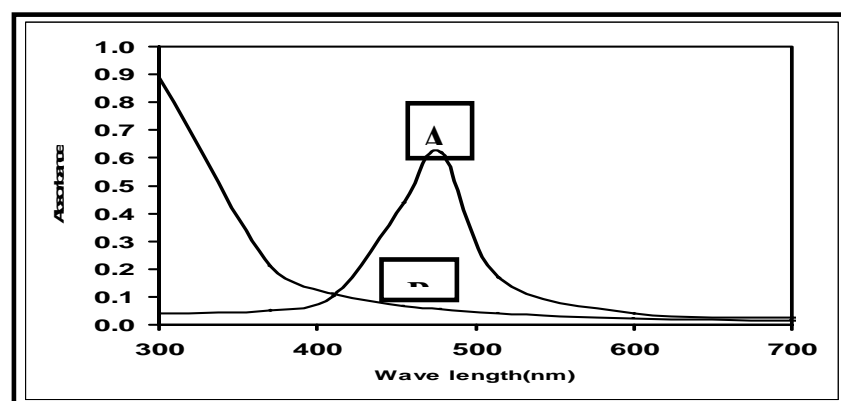

Fig. 2: Absorption spectra of ($20 \mu\text{g.ml}^{-1}$) of AMX treated as described under procedure and measured against blank and the reagent blank measured against distilled water.

Configuration designs:

The FIA configuration used to determine AMX was designed to provide different reaction conditions for magnifying the absorbance signal generated by reaction of AMX with DPNA in alkaline medium. Maximum absorbance intensity was obtained when the sample was injected into a stream of 5 mM DPNA and then combined with 20 mM sodium hydroxide.

Concentration of hydrochloric acid:

The effect of different acid concentrations (used for preparing the diazotized reagent) were studied in the range of 16 to 40 mM. A concentration of 24 mM gave the highest absorbance and was chosen for further use (Fig 3).

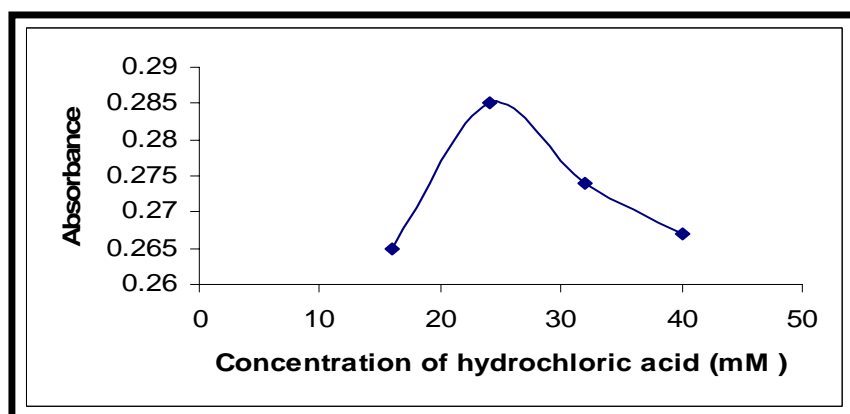

Fig.3: Effect of the concentration of HCL (mM).

Concentration of diazotized reagent:

The effect of various concentrations of DPNA solution were investigated in the range of 1-10 mM. A concentration of 5 mM gave the highest linear absorbance and was chosen for further use. The results are shown in (Fig 4).

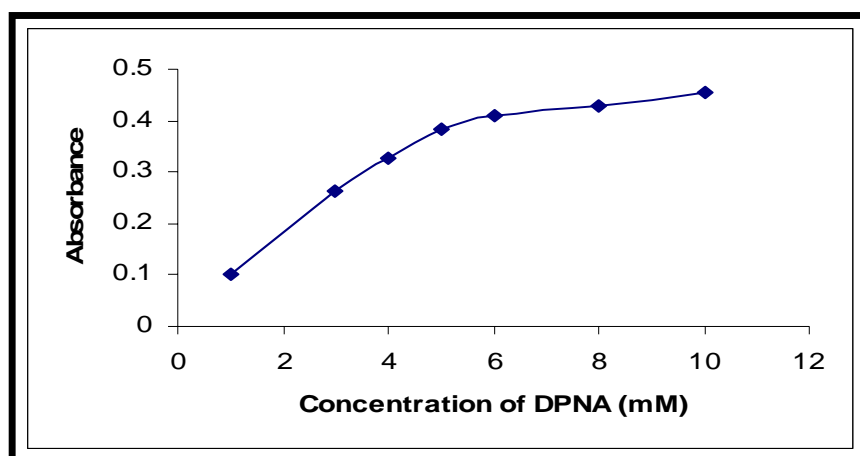

Fig.4: Effect of the concentration of DPNA (mM).

Concentration of sodium hydroxide:

Sodium hydroxide was found necessary for developing the color product and increase its stability. The effect of Sodium hydroxide in the concentration range of 10-100 mM was investigated and a greatest absorbance intensity was obtained with 20 mM (Fig 5).

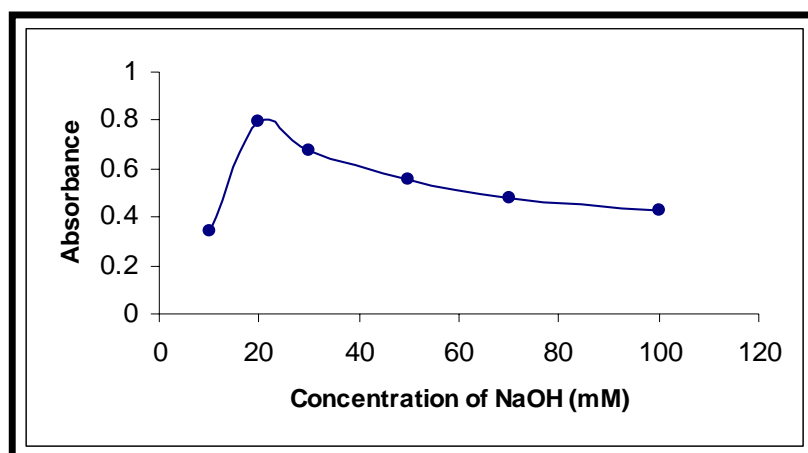

Fig.5: Effect of the concentration of sodium hydroxide (mM).

Effect of flow rate:

Effect of flow rate on the sensitivity of the colored product was studied in the range of 0.5-3.5 ml.min⁻¹. The results obtained (Fig 6) showed that the absorbance increased up to a flow rate of 1.5 ml.min⁻¹ (0.75 ml.min⁻¹ in each channel) and decreased for greater flow rates. A total flow rate of 1.5 ml.min⁻¹ was chosen for further use and with this flow rate of a sampling rate of 60 h⁻¹ was achieved.

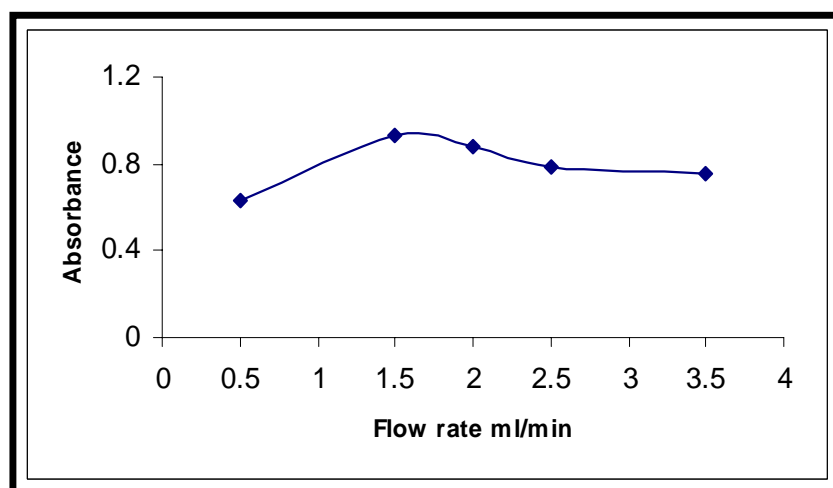

Fig.6: Effect of total flow rate (ml min⁻¹).

Effect of reaction coil length:

Coil length is an essential parameter that affected on the sensitivity of the colored reaction product and was investigated in the range of 25-250 cm.

The results obtained showed that a coil length of 100 cm gave the highest absorbance as shown in (Fig.7) and was used in all subsequent experiments.

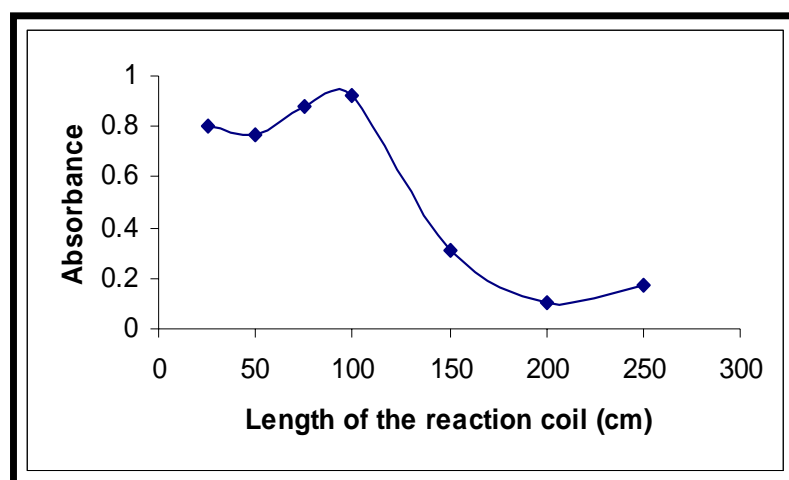

Fig.7: Effect of the length of the reaction coil in (cm).

Effect of injection sample volume:

The volume of injection sample was varied between 50-250 μ l ranges at chosen volumes of (50, 100, 150, 200 and 250 μ l). Inside this range the absorbance was increased as the injected volume was increased up to injected volume of 150 μ l and decreased for greater injected volumes (Fig. 8). A loop of 150 μ l gave the best absorbance and was used in the recommended procedure.

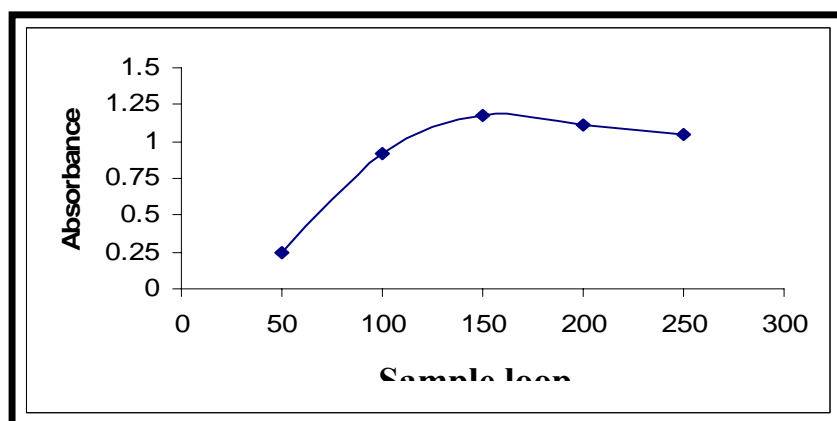

Fig.8: Effect of sample loop (μ l).

Determination of molar ratio and stability of the dye product:

The stoichiometry of the reaction between AMX and DPNA was investigated using Job's method for continuous variation (19) and FIA

technique under the optimized conditions. The results obtained (Fig. 9) show that 1:1 dye product is formed between AMX and DPNA.

The dye formed was soluble in water, the apparent stability constant was calculated by comparing the absorbance of a solution containing stoichiometric amount of AMX and DPNA with that of a solution containing five-fold excess of DPNA reagent. The stability constant of the dye in water under the described experimental conditions was $6.94 \times 10^3 \text{ L.mole}^{-1}$.

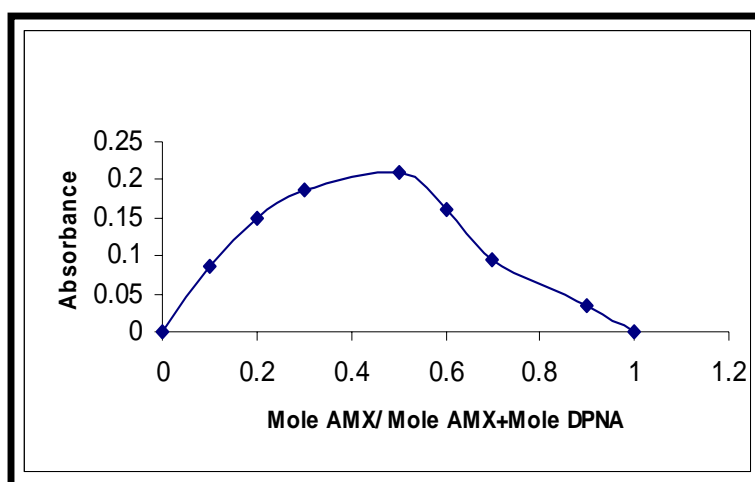

Fig.9: Study of the mole ratio of the reaction between AMX and DPNA.

Interferences:

Interference studies were carried out in order to investigate the effect of excipients that might be present in AMX dosage forms. Thus, no interference was observed from sucrose, lactose, talc, starch, polyvinylpyrrolidone (PVP) and Mg-stearate in the determination of AMX by coupling reaction with DPNA. The study was carried out by analyzing synthetic sample solutions containing $10 \mu\text{g. ml}^{-1}$ of AMX and excess amount (10 fold excess) of each excipient; none of these substances interfered seriously.

Optical characteristics:

In order to test whether the reddish-orange product formed obeys Beer's law or not, a series of solutions containing varying amounts of AMX were prepared, each as four replicates and the absorbances were recorded against the reagent blank at 478 nm. The Beer's law limits, the regression equation, correlation coefficient and limit of detection are summarized in (Table 1). The precision and accuracy of the proposed method were studied by analyzing solutions containing known amounts of AMX within the Beer's law limits, and the results indicate that a high precision and accuracy of the

method (Table 2) were obtained. Finally, the proposed method was fast with a simple through put of 60 injection h⁻¹.

Application of the method:

The optimized FIA-spectrophotometric system was used to determine AMX in some commercial pharmaceuticals (capsules and injections). The results in (Table 3) are in accordance with those obtained by the official spectrophotometric method (2) using imidazole-mercury reagent. Statistical analysis (20), F-and T-test, reveals that there is no significant difference in precision and accuracy between the proposed method and the official spectrophotometric method.

Conclusion:

The proposed automated FIA method is rapid, sensitive, precise and accurate, with a high sample through put and low reagent consumption. Interferences from common excipients are limited and the method can be used for the routine analysis of commercial formulations instead of the tedious official method.

Finally, in comparison with other possible FIA-spectrophotometric methods (Table 4), the proposed method offers the following advantages: a wider determination range; a higher sensitivity; and a slightly higher accuracy.

Table.1: Optical characteristics and analytical data of AMX.

Parameter	Value
Color of the dye product	Reddish-orange
λ_{max} (nm)	478
Regression equation	Y=0.011X+0.0851
Linear range ($\mu\text{g ml}^{-1}$)	0.5-100.0
Correlation coefficient	0.9997
Limit of detection ($\mu\text{g ml}^{-1}$)	0.104
Reproducibility % for 70 $\mu\text{g ml}^{-1}$	0.64
Recovery,% for 70 $\mu\text{g ml}^{-1}$	99.83
Through-put (hr ⁻¹)	60
Molar ratio of the product (AMX:DPNA)	1:1
Stability constant (L.mole ⁻¹)	6.94×10^3

Table 2: Accuracy and precision of the proposed method.

Conce. Of AMX ($\mu\text{g ml}^{-1}$)		Recovery %*	RSD %*
Present	Found		
20.000	20.336	101.680	0.984
60.000	60.809	101.348	0.714
90.000	69.881	99.830	0.641

*For five determinations.

Table 3: Application of the proposed and official methods to the determination of some AMX drugs in dosage forms.

Drug forms	FIA method		Official method Recovery %*
	Recovery %*	RSD %*	
Amoline (injection500mg) Oubari-pharma-syria	100.76	1.16	102.50
Amoxicillin(injection500mg) Pan pharma-France	98.15	0.91	101.00
Acamoxil (capsule 250mg) ACAI-Iraq	98.85	0.41	102.00
Amoxicillin (capsule250mg) Pharm-Inter-Belgica	102.77	0.84	99.00
Amoxicillin (capsule250mg) Ajanta-Limited-India	101.85	1.44	98.00
Amoxicillin (capsule 250mg) SDI-Iraq	101.73	0.56	99.00

* For five determinations.

Table 4:Comparison of the proposed method with some of the FIA-spectrophotometric methods for the determination of AMX.

Reagent	Coloured species	Wave length (nm)	Beer's low Range (ppm)	R.S.D%	Sample through put h-1	Ref.
Folin-ciocaleu (sodium tungstate , sodium molybdate and phosphoric acid)	Radical cation	715	1-20	1.26	Not reported	21
1- Nitroso-2 naphthol with Ce(IV) or Pb(IV)	Oxidative coupling	540	41.94 - 335.52	2.00	40	22
DPNA	Diazotization and coupling	478	0.5-100.0	0.98	60	This work

References

- 1- Delgado, J. N.; Remers, W. R. (1995). Text Book of Organic Medicinal and Pharmaceutical Chemistry. (Eds.), Wilson and Gisvolds. Lippincott, Philadelphia, 10th. Ed. Chapter 7.
 - 2- British Pharmacopoeia. (1993). H. M. Stationary Office, London.
 - 3- Belal, F.; El-kerdawy, M. M.; EL-Ashry, S. M.; El-Waseef, D. R. (2000). Kinetic spectrophotometric determination of ampicillin and amoxicillin in dosage forms. *IL FARMACO*. 55: 680.
 - 4- Nagaralli, B. S.; Seetharamappa, J.; Melwanki, M. B. (2002). Sensitive spectrophotometric methods for the determination of amoxicillin, ciprofloxacin and piroxicam in pure and pharmaceutical formulations. *J. Pharm. Biom. Anal.* 29: 859.
 - 5- Uslu, B.; Biryol, I. (1999). Voltammetric determination of amoxicillin using a poly (Nvinyl imidazole) carbon paste electrode. *J. Pharm. Biom. Anal.* 20: 591.
 - 6- Biryol, I.; Uslu, B.; Kucukyavuz, Z. (1998). Voltammetric determination of amoxicillin using carbon paste electrode modified with poly (4-vinyl) pyridine, *STP. Pharm. Sci.* 8: 383.
 - 7- Kapetanovic, V.; Veselinovic, D. (1998). Fluorescence studies of amoxicillin. *Arch. pharm.* 321: 559.
 - 8- Navarro, P. G.; El-Bekkouri, A; Reinoso, E. R. and Bult, A. (1990). Spectrofluorimetric study of the degradation of alpha amino beta-lactam antidiotics catalysed by metal ions in methanol. *J. Pharm. Biom. Anal.* 8: 49.
 - 9- Vanopstal, M. A.; Wolters, R.; Blauw, J. S.; Vankrimper, R. C.; Vankrimper, W. P. and Bult, A. (1990). Determination of penicillins in pharmaceutical formulations by flow injection analysis. *J. Pharm. Biom. Anal.* 8(1): 49.
 - 10- Boison, J. O.; Keng, L. J. Y. (1998). Determination of ampicillin and amoxicillin by liquid chromatography in bovine muscle. *AOAC*. 81: 1113.
 - 11- Vanzijveld, J.; Van Hoogdalem, E. J. (1999). Application of semipermeable surface column for the determination of amoxicillin in human blood serum. *J. Chromatography*. 726: 169.
 - 12- Al-Abachi, M. Q.; Haddi, H. and Al-Abachi, A. M. Q. (2005). Spectrophotometric determination of amoxicillin by reaction with N,N-Dimethyl-p-phenylene diamine and potassium hexacyanoferrate(III). *Anal. chimi. acta*. 554: 184.
 - 13- Simoes, S. S.; Medeiros, E .P.; Gaiao, E. N.; Lyra, W. S.; Moreira, P. N. T.; Arauja, M. C. U; Silva, E. C. and Nascimento, V. B. (2006). Flow injection determination of metronidazole through spectrophotometric
-

- measurement of the nitrite ion produced upon alkaline hydrolysis. *J. Braz. Chem. Soc.*17(3): 609-613.
- 14- Metwally, M. E. (1999). Analysis of sulfa drugs in pharmaceutical dosage forms and biological samples. *Anal. Sci.* 11:979.
 - 15- Rodriguez, L. A.; Romero, J. E.; Tena I.E. and Coque, M. C. G. A. (1999). Flow injection spectrophotometric determination of phenolic drugs and carbamate pesticides by coupling with diazotized 2,4,6-Trimethylaniline. *J. of AOAC* 82: 937.
 - 16- AL-Abbasi, K. M. (2000). Ph.D.Thesis, Mosul University. 81-99.
 - 17- Salem, H. (2004). Selective spectrophotometric determination of phenolic β -lactam antibiotics in pure forms and in their pharmaceutical formulations. *Anal. Chim. Acta.* 515: 333-341.
 - 18- Morrison, R. T. and Boyd, R. N. (1974). *Organic Chemistry*. 3rd Ed. Allynand Bacon, Inc. USA. 801-805.
 - 19- Hargis, L.G. (1988). *Analytical Chemistry*. Prentice-Hall Inc. New Jersey.
 - 20- Sanders, D. H.; Murph, A. F. (1976). *Statistics*. Mc.Graw-Hill, New York.
 - 21- Thongpam, T. <http://www.chiangmai.ac.th/> abstract accessed in 05/07/2004.
 - 22- Constantinos, G. A.; Koupparis, M. A. (1990). Automated flow injection spectrophotometric determination of para-and meta-substituted phenols of pharmaceutical interest based on their oxidative condensation with 1-Nitroso-2-naphthol. *Analyst.* 155:309.
-

*